

3U VPX 56 CHANNEL 25G ETHERNET SWITCH

AMPHENOL FAMILY OF RUGGEDIZED ETHERNET SWITCHES

PDS - 313

3U Conduction Cooled (CC) 25G SWITCH:
CF-020400-069

3U Air Cooled (AC) 25G SWITCH:
CF-020400-070

3U 25G Rear Transition Module (RTM):
CF-020400-069R

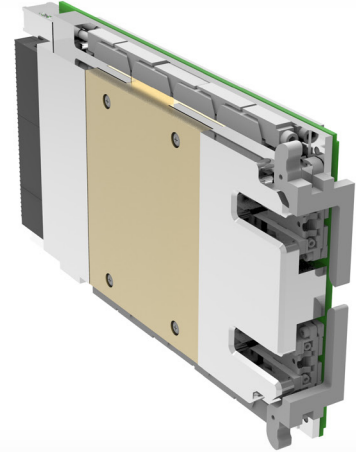

The 56 channel 25G ethernet switch is configurable for system connectivity, speeds, port types, and inter-operation of various media converters and connectors for system interfacing. The configuration to meet system requirements is achieved through superior product design. Each port is capable of 100G, 25G, 10G, 1G, or 100M Ethernet. The backplane consists of 32 channels of SERDES 25GBase-KR channels and the top of the board has 24 channels of 25GBase-SR fiber optics. Any four channels of the board can be ganged together for a 100G connection. The switching throughput is 1.4Tbps when using all 56 ports on the switch. In addition, the switch is non-blocking and low-latency for high-throughput architectures and applications. Finally, the management software provides a command line interface, SNMP, and other web based options for configuring the switch which is capable of a full complement of virtualization, quality of service, security, tunneling, PTP, and other capabilities.

FEATURES & BENEFITS

- Up to 56 channels of 25G interfaces on a single card. Ports are configurable for 100G, 25G, 10G, 1G, and 100M speeds.
- Line rate forwarding up to 1.4Tbps
- L2 / L3 managed switch
- PTP IEEE 1588v1/v2 support
- VITA 46 3U VPX available in conduction and air cooled configurations for -40-85C environments as well as harsh vibration profiles

ORDERING INFORMATION

Part Number	Cooling	Top Fiber	VPX SERDES
CF-020400-069	Conduction	24	32
CF-020400-070	Air	24	32
CF-020400-069R Rear Transition Module			

For other options, please contact factory.

BLOCK DIAGRAM

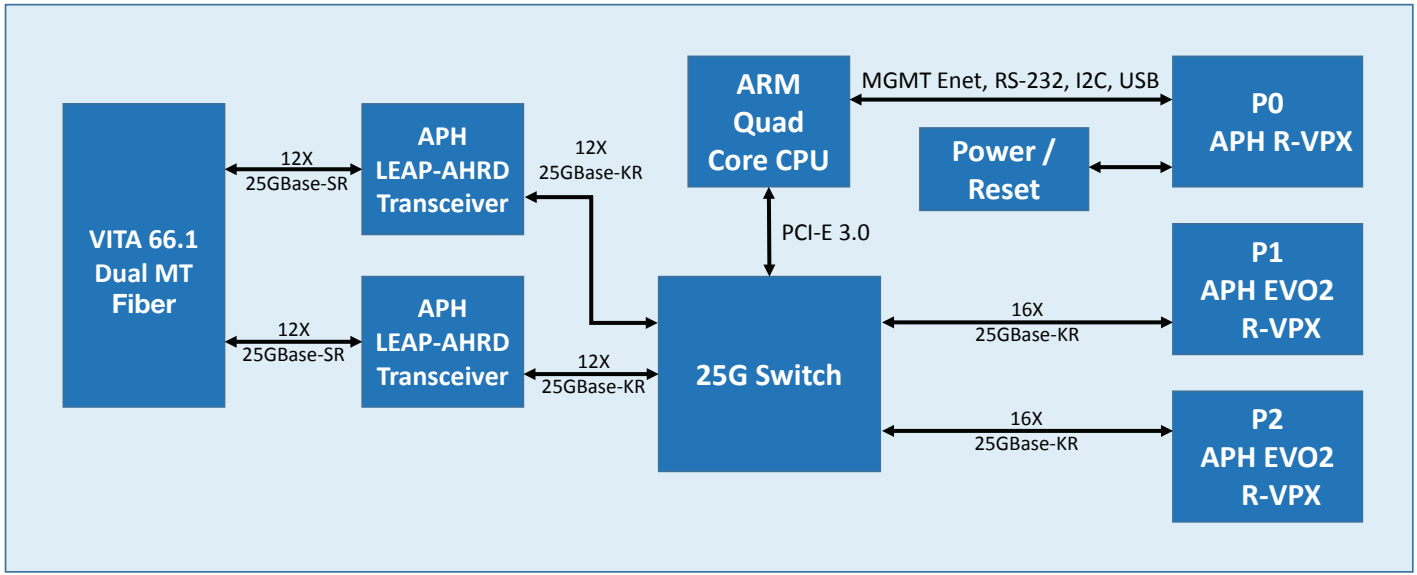

ETHERNET INTERFACES

- 1X 100/1GBase-T Management Interface
- 32X 25GBase-KR copper off P1 and P2 - Can be configured from 100M to 25GBase-KR
- 24X 25GBase-SR fiber off VITA connector on top of board

OTHER FEATURES

- Built in test on each port
- DHCP client, server per VLAN (4000+ available) instantiated
- Status interface – temperature, serdes, set speed, port packet counters
- NTP, ping, FEC, IGMP
- SNMP
- Custom routing
- Syslog
- SSH
- Web servers for status

TECHNICAL SPECIFICATIONS

LAYER 2 SWITCHING ENGINE

- 802.1Q-compliant bridging
- Large forwarding database for MAC entries, IGMPv3/MLDv2 IP multi-cast, FCoE entries, and router host entries
- Learning and forwarding based on virtual ports (ePorts) and virtual bridge domains
- L2 ECMP and link aggregation groups

LAYER 3 WIRE-SPEED ROUTING ENGINE

- Longest prefix match for IPV4/6 and IP Multi-cast
- Policy based routing
- VRF, VRF-Lite, BGP/MPLS IP VPNs
- Multi-cast routing supporting PIM-SM/DM and PIM-bidirectional routing protocols
- ECMP routing for load balancing traffic
- Network address translation (NAT 44,66)

BLOCK DIAGRAM 3U REAR TRANSITION MODULE (RTM)

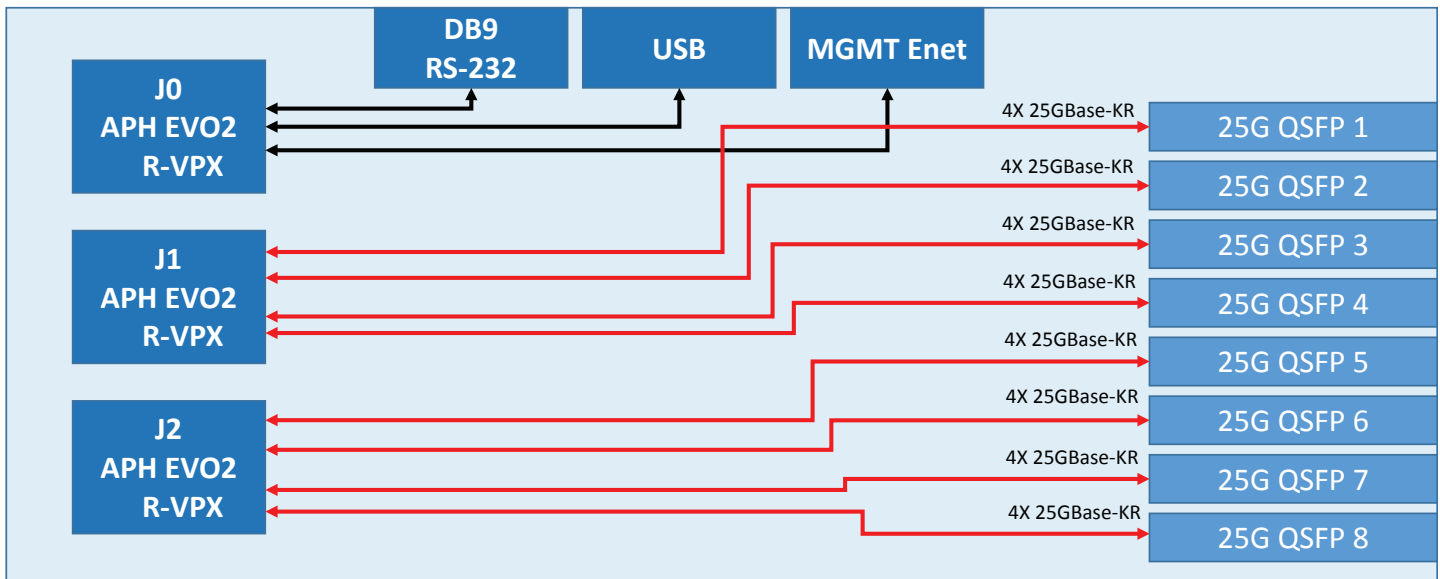

FIBER OPTIC CABLE TO TOP OF SWITCH

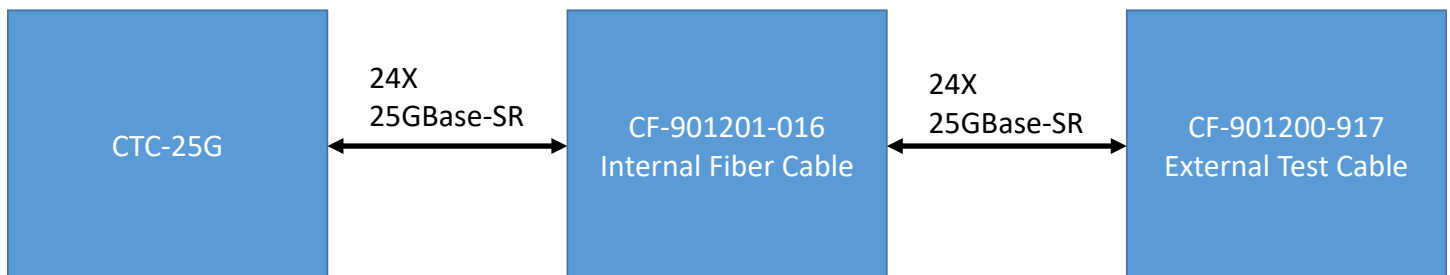

CF-901201-016: CONNECTOR DETAILS

CABLE FIBER OPTIC: 2 48MT TO 2MT MODULE

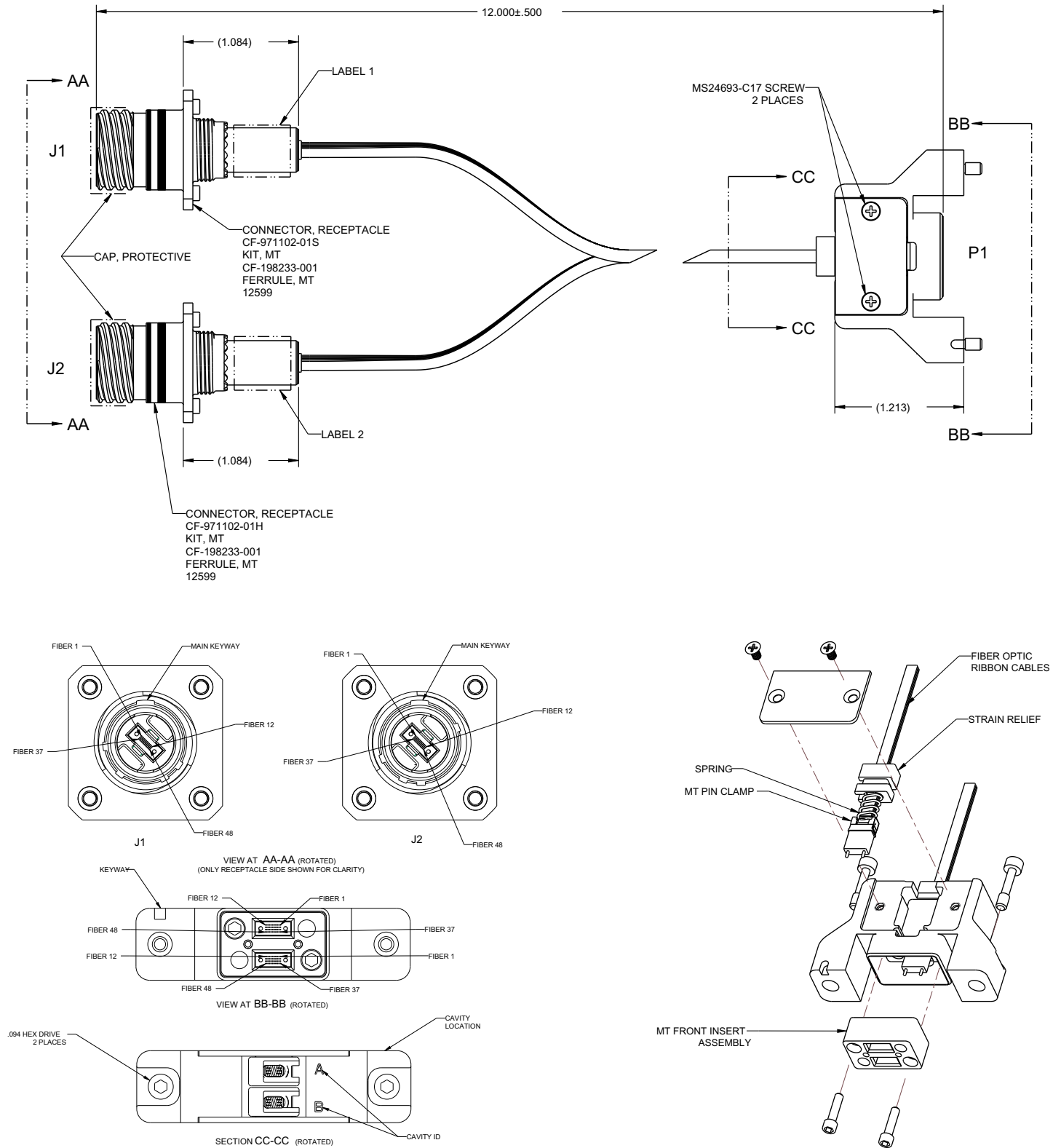

CF-901200-917: CONNECTOR DETAILS

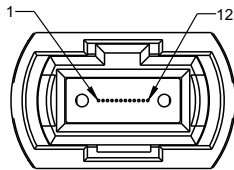
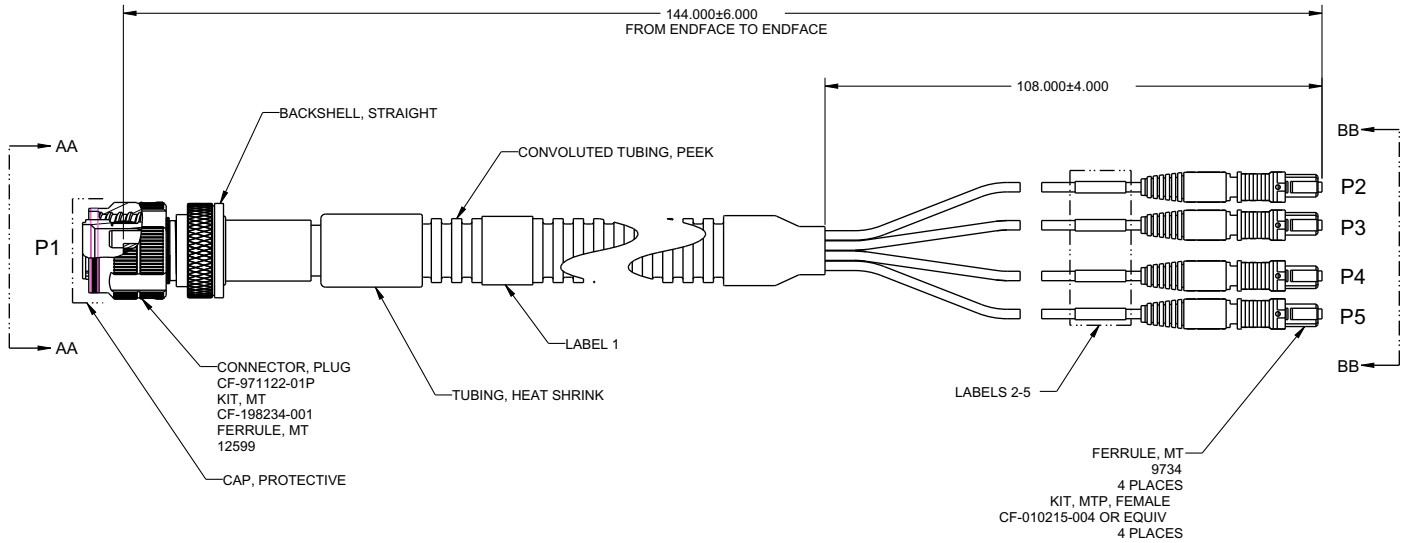

VIEW AT BB-BB

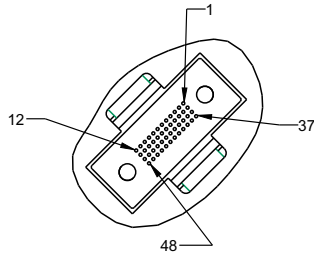

DETAIL A

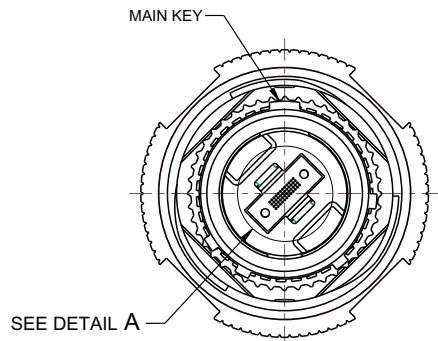

INTRODUCTION

The changes in technology where R-VPX connectors are used has rapidly evolved in recent years, specifically driving a demand for higher data rates from copper contact based connectors, which have typically resided in the 10 & 16 Gbps speed realm. The fastest connector in the market to date is performing to 25 Gbps, but the market demands even faster speeds. This is where Amphenol's new EVO2 R-VPX connector is designed to dominate; as the first and only 32 Gbps+ VITA 46.30 connector available.

Eye pattern @ 25.8 Gbps

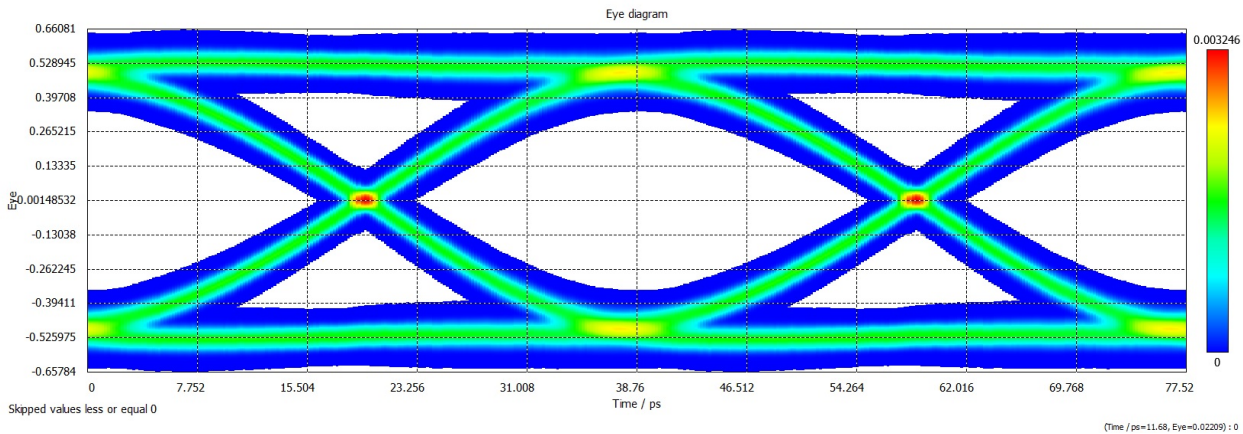

Note: PRBS-23 signal through D7E7-E7F7 pair with all surrounding pairs as active aggressors

DESIGN AND CONSTRUCTION

Amphenol Corporation is uniquely integrated to be able to provide collaborative design results, which R-VPX EVO2 development required. The expertise for this project was the same team that developed R-VPX and R-VPX EVO1, a blend of Amphenol design teams from AAO in Sidney, NY and Amphenol TCS in Nashua, NH. This team designed R-VPX EVO2 by borrowing proven characteristics from our R-VPX and R-VPX EVO1 series connectors, using high performance dielectric PCB material, reducing the surface area of the contacts in both connectors, and tirelessly tuning and testing the trace geometries for signal integrity to match impedance goals. The latter changes also reduce crosstalk between pairs. The addition of the organizer reduced the impedance in the gap at the mounting interface between the backplane connector and the backplane PCB. These changes enable the speed performance improvement in this new connector series while meeting all of the requirements of the VITA 46.30 specification and maintaining all backwards intermateability. See the next page for visual differences.

The new design resulted in three noticeable visual differences for end users:

1. The R-VPX EVO2 compliant eye size on the module (daughter card) connection region is smaller as compared to R-VPX connectors. (See Figure 1)
2. The R-VPX EVO2 compliant eye is smaller on the backplane connector compared to both R-VPX and R-VPX EVO1 connectors. (See Figure 2)
3. The R-VPX EVO2 backplane connector adds an organizer to the compliant PCB tail connection region. (This organizer remains on the interface and poses no additional steps to the customer during the installation of the connector. (See Figure 2)

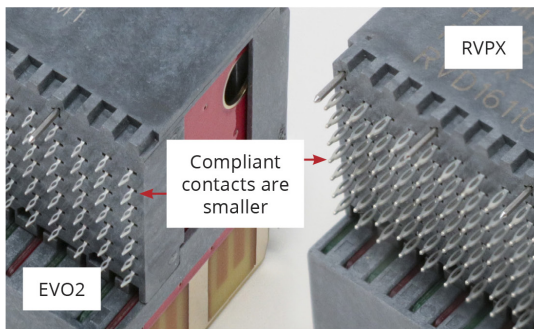

Figure 1 - Daughtercards

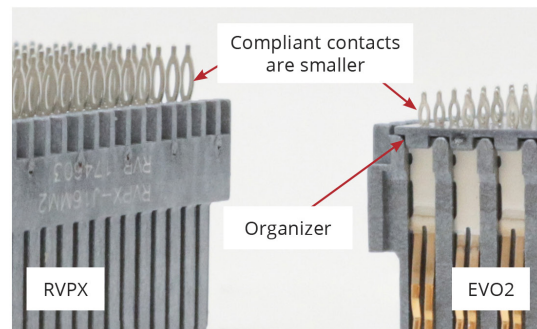

Figure 2 - Backplanes

THE VITA ECOSYSTEM

R-VPX EVO2 is a VITA 46 compliant connector system. The R-VPX EVO2 connectors, like previous R-VPX and R-VPX EVO1 versions, are fully intermateable with the aforementioned connectors. (as well as RT2, RT2-R, & RT3 from TE) Intermountability is described below:

	R-VPX Back-plane	R-VPX EVO1 Back-plane	R-VPX EVO2 Back-plane	R-VPX Module	R-VPX EVO1 Module	R-VPX EVO2 Module	RT2/RT2R	RT3
R-VPX Backplane	•	•					•	
R-VPX EVO1 Backplane	•	•					•	
R-VPX EVO2 Backplane			•					•
R-VPX Module				•			•	
R-VPX EVO1 Module					•	•		•
R-VPX EVO2 Module					•	•		•

Amphenol has mechanically tested RT3 to ensure intermateability/ intermountability with R-VPX EVO2 DC/BP and R-VPX EVO1 DC and RT2-R for intermateability/intermountability with R-VPX DC/BP.

EVO2 CONNECTOR VERIFICATION

Amphenol Aerospace's R-VPX EVO2 connector passed connector qualification per the VITA 46 and Telecordia GR-1217-CORE test specifications. Testing was conducted by a combination of Contech Research of Rumford, RI and by Amphenol TCS test lab in Nashua, NH. Amphenol Aerospace R-VPX EVO2 and TE's RT3 connectors were intermated through relevant tests in both the VITA 46 and Telecordia GR-1217-CORE testing. Tests performed included, but were not limited to the list below. Test reports can be provided upon request.

- LCR
- Durability
- Temp Life
- Mechanical Shock
- Thermal Aging
- Mate/Unmate
- Dust
- Random Vibration

CONCLUSION

Amphenol Aerospace's R-VPX EVO2 connectors are the fastest VITA 46.30 connectors in the world, achieving data rates in excess of 32 Gbps while meeting the specification requirements. R-VPX EVO2 connectors will enable the embedded market to meet and exceed the demanding requirements of today's protocols including 25G Ethernet (100GBASE-KR4) and PCIE Gen 5 (32G).

LEAP-AHRD ON BOARD TRANSCEIVER

AMPHENOL HIGH SPEED SOLUTIONS RUGGED DEVICE

Amphenol 300Gb/s Leap-AHRD® High-Speed Optical Module is faster, smaller, more cost and power efficient than most conventional data center interconnects.

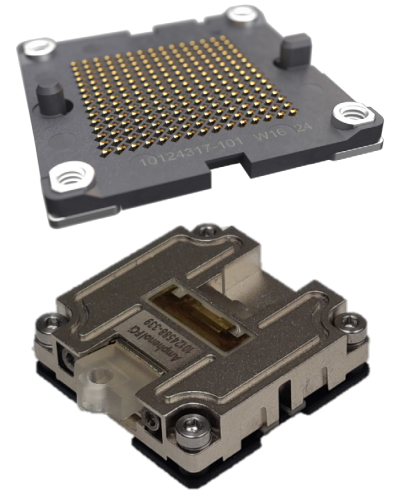

FEATURES & BENEFITS

- 300Gb/s High-Speed Optical Module
- Small, fast, high density, and power efficient
- Capable of speeds up to 25Gbps and distances up to 100 meters
- 300Gbps total through-put requires only one square inch of board space and 5.4W of power
- Optical cable can be routed above around other components in the design
- Integrated heat sink design
- Class 1M laser version available
- Enhanced Bit Error Rate (1e-12) requires no or limited FEC
- Compatible with Amphenol socket
- Easy to install
- Transceivers can be placed in 2-dimensional layout grid with 1" pitch between adjacent transceivers
- Uses 2.5x less board space than QSFP28 (12-channels)
- Ethernet transmission distance up to 100m (multi mode fiber)
- Uses off-the-shelf MT optical interface
- No through holes to connect transceiver – one side of board only
- Allows for transceiver optimization and monitoring connection discovery, channel diagnostics, and signal status monitoring

R-VPX EVOLUTION

HIGH SPEED

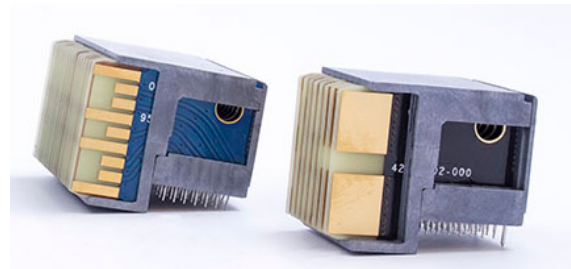

AMPHENOL INTRODUCES R-VPX EVOLUTION MODULE CAPABLE OF 16+ GBPS DATA RATE

Evolution is specifically designed to support the latest high-speed protocols while still meeting open VPX requirements. Evolution meets the performance requirements of VITA 46 & 47. Evolution is designed to be intermateable with existing VITA 46 backplane connectors and still achieve 16Gbps of performance. This connector system is optimized for speed and ruggedized to handle harsh environment requirements in military applications across the board.

FEATURES & BENEFITS

- PCIe Gen 4
- 1000BASE-KX
- 10GBASE-KX4
- 100GBASE-KR4
- Infiniband SDR, DDR, and QDR
- Serial RapidIO 12.5 Gbaud